



DAYTECH
— ENERGY —

CLEAN ENERGY
Series
User Manual

12/24/48 VDC MPPT Solar Battery Charger Range

1 Overview

Daytech's CLEAN ENERGY Series solar controller is a Maximum Power Point Tracking (MPPT) technology with tracking efficiency greater than 99.9% and charging conversion efficiency up to 98%.

The CLEAN ENERGY Series of Solar Battery MPPT Charge Controllers offers a high-performance solution for your off-grid, stand-alone power or remote solar power system needs. With advanced MPPT (maximum power point tracking) control algorithm for solar power optimisation, on-board LCD screen, aluminium heatsink for heat dissipation and battery charge control and protection features, the CLEAN ENERGY Series is reliable, safe and practical.

The charge controller is usable for a wide variety of situations, allowing fast and accurate tracking for the best use of your photovoltaic array. You need a high-quality charge controller, to obtain the maximum solar energy to safely charge your 12V, 24V or 48V batteries within a shorter time period. The CLEAN ENERGY Series delivers on this promise, remarkably improving energy efficiency, providing safety features and allowing your batteries to last significantly longer.

Remotely or locally monitor your system with local computer plugin interface, or another monitoring device, such as Daytech's IoT-SmartNode. All-round electronic fault detection, self-test and diagnostic function and enhanced electronic protection functions reduces the possibility of damages to the system components resulting from installation errors or system failures.



1.1 Features

- Maximum Power Point tracking with tracking efficiency greater than 99.9%.
- High charge conversion efficiency up to 98%
- Built in LCD for viewing the controller's data and working state
- Real-time energy statistics function
- 12, 24 and 48V battery modes
- Compatible with Liquid, Gel, AGM, and Lithium chemistries
- External temperature sensor with automatic temperature compensation
- Four stage battery charger: MPPT, boost, equalisation, and float
- Multiple load control modes: Always on, dusk to dawn, evening, and manual
- IoT Wireless communication, Bluetooth communication, or RS-485 communications available
- Bluetooth communication distance up to 10 meters
- Can be monitored through IoT to a remote PC program
- Real-time fault alarm
- Charge and discharge data can be displayed per item grouping or by month
- Excellent EMC and thermal design
- Fully automatic electronic protection

Daytech Pty Ltd

Web: www.daytech.io | **Email:** sales@daytech.io | **Phone:** 1300 866 970

Head Office & Factory: 614-616 Marion Road, Park Holme, SA 5043

Warehouse: 1167A South Rd St Marys SA 5042 | **Daytech Pty Ltd** | **ABN: 84 602 165 024**



2 Dimensions

2.1 DT2010A

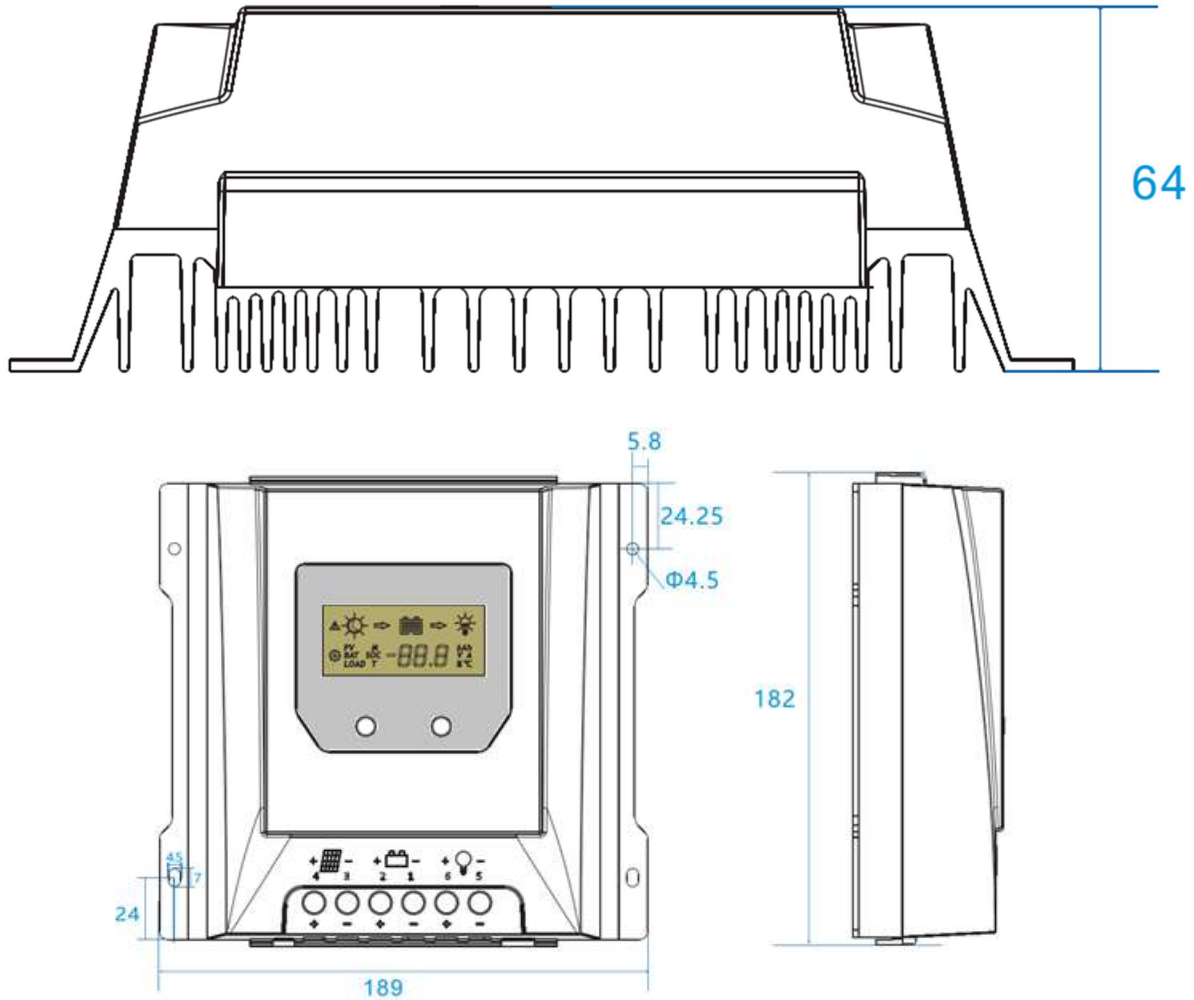

Daytech Pty Ltd

Web: www.daytech.io | Email: sales@daytech.io | Phone: 1300 866 970

Head Office & Factory: 614-616 Marion Road, Park Holme, SA 5043

Warehouse: 1167A South Rd St Marys SA 5042 | Daytech Pty Ltd | ABN: 84 602 165 024



2.2 DT3010A and DT4010A

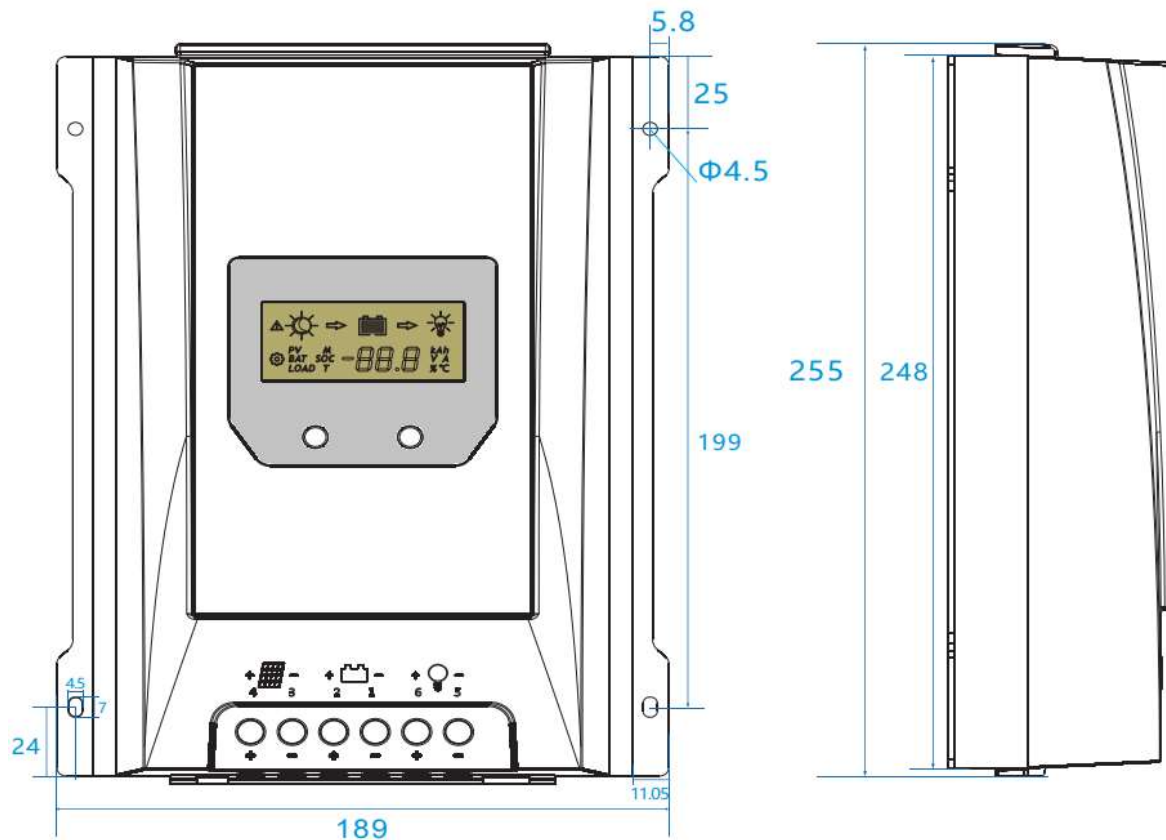
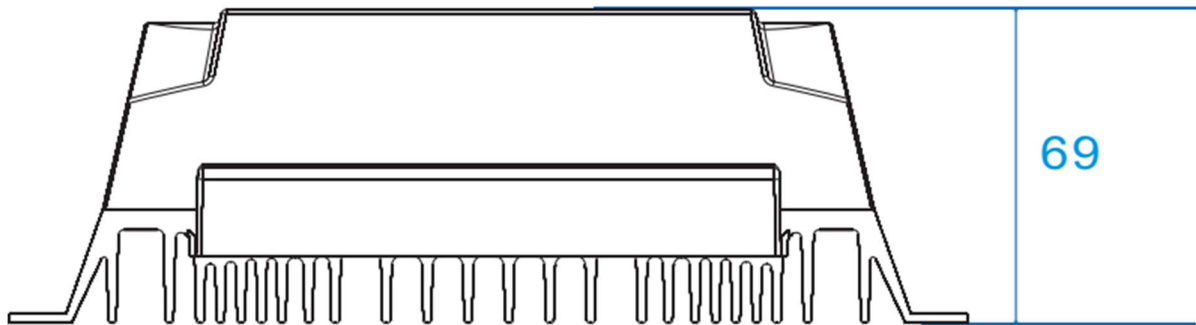

Daytech Pty Ltd

Web: www.daytech.io | Email: sales@daytech.io | Phone: 1300 866 970

Head Office & Factory: 614-616 Marion Road, Park Holme, SA 5043

Warehouse: 1167A South Rd St Marys SA 5042 | Daytech Pty Ltd | ABN: 84 602 165 024



3 User Interface Diagrams

3.1 Interface of DT2010A

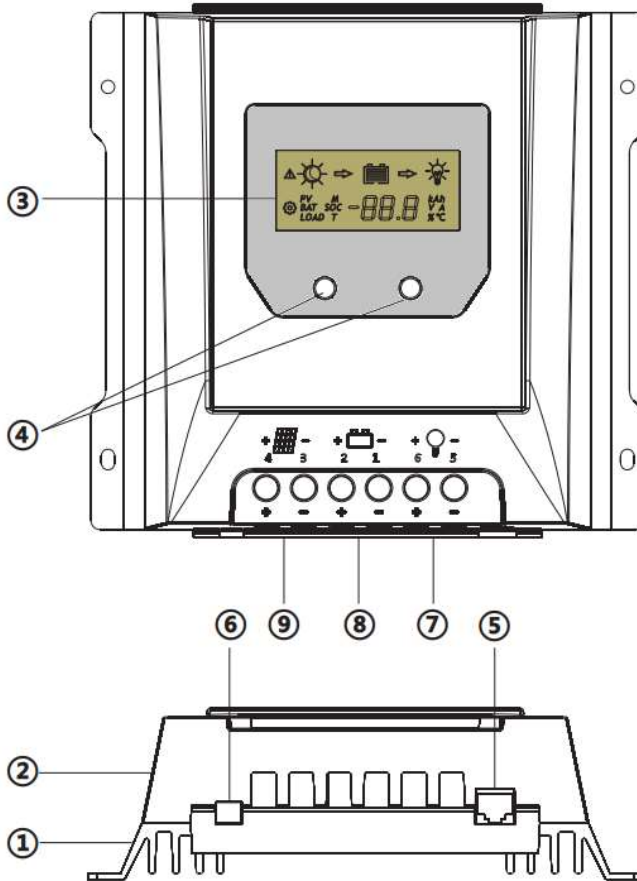

- ① Heat Sink
—dissipate controller heat
- ② Plastic Case
—Internal protection
- ③ LCD
—Display settings and operating status,
system parameters
- ④ Key: MENU OK
Set and view the operating parameters
- ⑤ RJ11 interface
—Connecting monitoring devices
- ⑥ Temperature Sensor Port
—Collect temperature information,
Temperature compensation.
- ⑦ Load Terminals
—Connected load.
- ⑧ Battery Terminals
—Connect the battery.
- ⑨ Solar module terminals
—Connected solar modules.



3.2 Interface of DT3010A and DT4010A

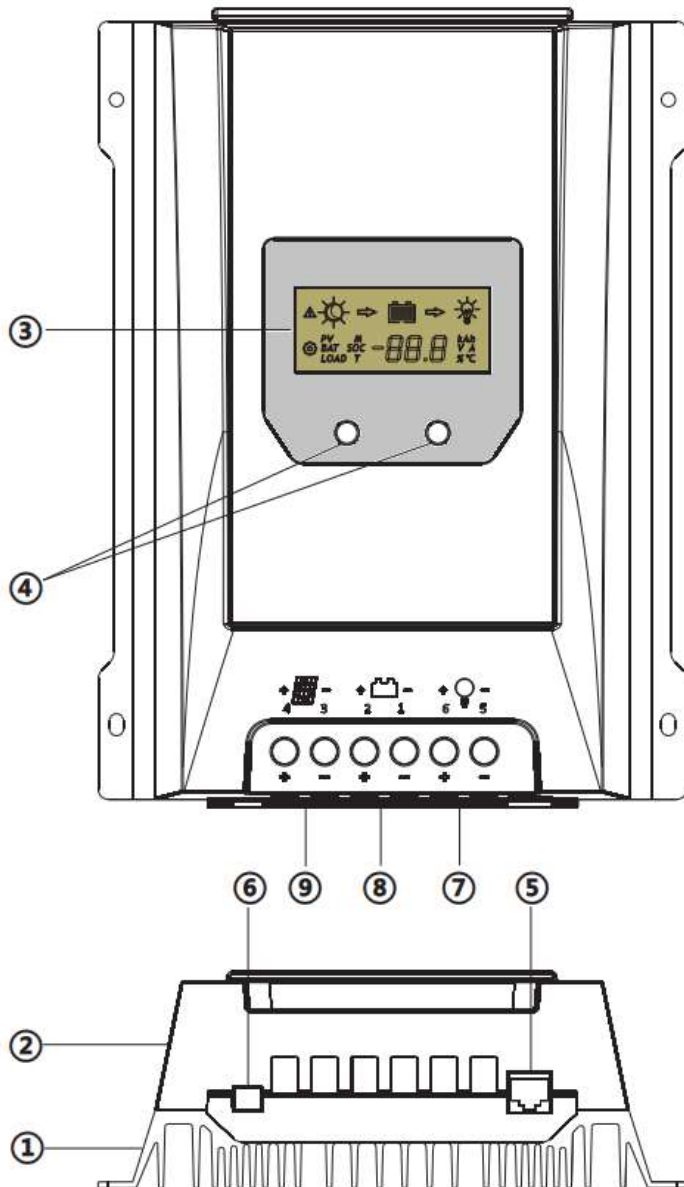

- ① Heat Sink
—dissipate controller heat
- ② Plastic Case
—Internal protection
- ③ LCD
—Display settings and operating status, system parameters
- ④ Key: MENU, OK
Set and view the operating parameters
- ⑤ RJ11 interface
—Connecting monitoring devices
- ⑥ Temperature Sensor Port
—Collect temperature information, Temperature compensation.
- ⑦ Load Terminals
—Connected load.
- ⑧ Battery Terminals
—Connect the battery.
- ⑨ Solar module terminals
—Connected solar modules.



4 Installation

CAUTION: Please read all instructions and precautions in this manual before installing the unit.

Installation to be performed by qualified personnel only.

4.1 Installation Notes

1. The solar charge controller can only be used in Photovoltaic (solar) systems in accordance with this user manual and within the specifications of other module manufacturers. No energy source other than a solar generator can be connected to the solar charge controller.
2. Before installing or adjustment of the controller, disconnect the solar modules and connection to the battery.
3. Never short circuit a battery **under any circumstances**. It is strongly recommended to install a fuse near or on the battery to prevent fire, or damage to equipment or persons.
4. Batteries can release flammable gas. Avoid sources of ignition around batteries. Ensure the battery is stored in a well-ventilated area.
5. Use insulated tools when working around batteries to prevent shorting the battery.
6. Wear eye protection when working around batteries.
7. Do not touch the battery terminals. Use insulated tools and keep your hands dry.
8. Keep the controller away from sources of water, heat, and direct sunlight.
9. After installation, ensure all connections are secure.

4.2 Mounting location

Do not mount the solar charge controller outdoors or in wet rooms. Do not subject the solar charge controller to direct sunshine or other sources of heat. Protect the solar charge controller from dirt and moisture. Mount upright on the wall on a non-flammable substrate. Maintain a minimum clearance of 15cm below and around the device to ensure unhindered air circulation. Mount the solar charge controller as close as possible to the batteries.

Mark the position of the solar charge controller fastening holes on the wall, drill 4 holes and insert dowels, fasten the solar charge controller to the wall with the cable openings facing downwards.

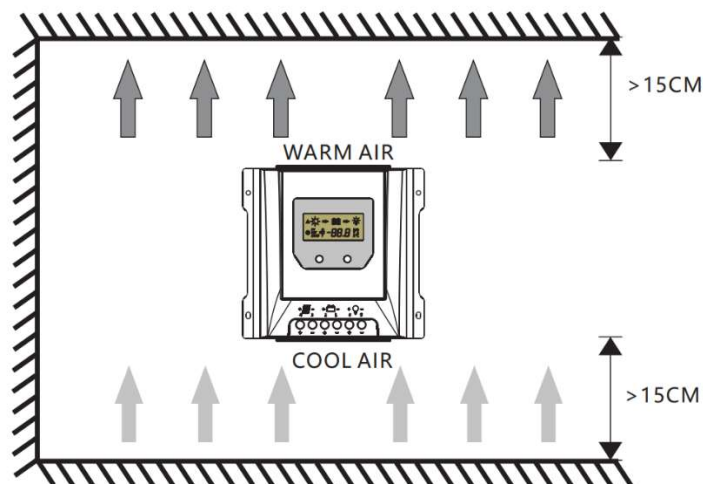

Daytech Pty Ltd

Web: www.daytech.io | Email: sales@daytech.io | Phone: 1300 866 970

Head Office & Factory: 614-616 Marion Road, Park Holme, SA 5043

Warehouse: 1167A South Rd St Marys SA 5042 | Daytech Pty Ltd | ABN: 84 602 165 024



4.3 Wiring Specifications

Wiring and installation methods must comply with national and local electrical specifications. The wiring specifications of the solar, battery and loads must be selected according to rated currents. See the following table for wiring specifications:

Model	Rated Charging Current	Rated Discharge Current	Solar wire size	Battery wire size	Load wire size
DT2010A	20A	20A	5mm ² /10AWG	5mm ² /10AWG	5mm ² /10AWG
DT3010A	30A	30A	6mm ² /9AWG	6mm ² /9AWG	6mm ² /9AWG
DT4010A	40A	30A	10mm ² /8AWG	10mm ² /8AWG	6mm ² /9AWG

Note: This wiring size is only for reference. If there is a long distance between the PV array and the controller, it is recommended to increase the wire diameter to reduce voltage drop and improve efficiency.

4.4 Connection

We strongly recommend connecting a fuse directly to the battery to protect any short circuit at the battery wiring. Solar PV modules create current whenever light strikes them. The current created varies with the light intensity, but even in the case of low levels of light, full voltage is given by the modules. So, protect the solar modules from incident light during installation. Never touch uninsulated cable ends, use only insulated tools, and make sure that the wire diameter is in accordance with the expected currents of solar charge controller. Connections must always be made in the sequence described below.

Daytech Pty Ltd

Web: www.daytech.io | Email: sales@daytech.io | Phone: 1300 866 970

Head Office & Factory: 614-616 Marion Road, Park Holme, SA 5043

Warehouse: 1167A South Rd St Marys SA 5042 | Daytech Pty Ltd | ABN: 84 602 165 024

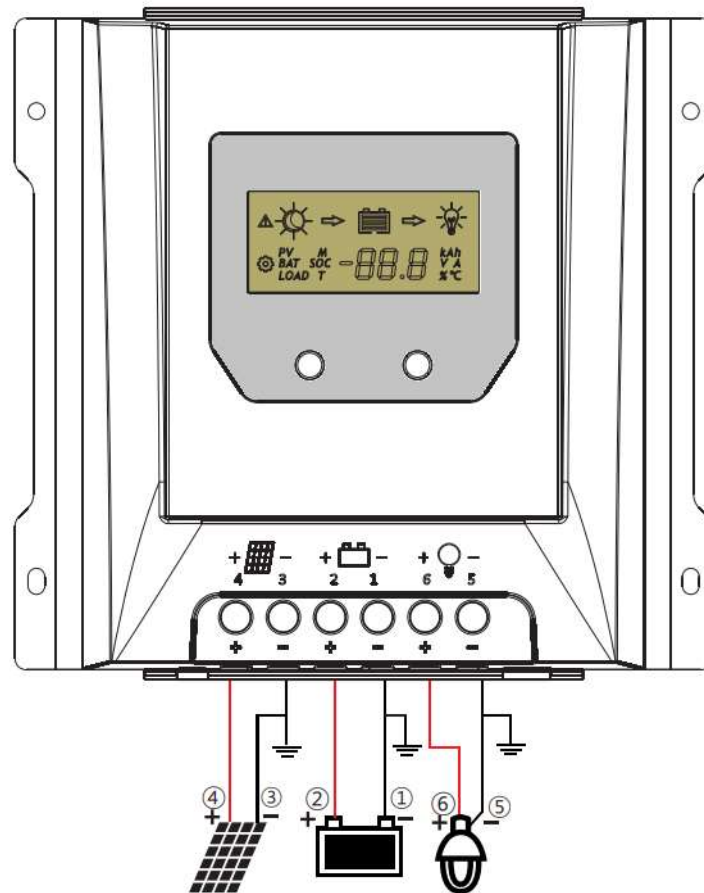

WARNING: Risk of electric shock. Exercise caution when handling solar wiring. The open circuit voltage of a PV array in direct sunlight can exceed 100V.

CAUTION: If the temperature sensor on the controller is disconnected, the ambient temperature will be assumed to be 25°C.

4.5 Procedure to install the Solar Charge Controller

1) Connect the battery

Connect the battery cable with the correct polarity to the middle pair of terminals on the solar charge controller (with the battery symbol). If the system is 12V, please make sure that the battery voltage is within 8.5V~15.5V. If the system is 24V, the battery voltage should be between 20V~30V. If the system is 48V, the battery voltage should be between 40V~60V. If the polarity is correct, the LCD on the controller will begin to show.

2) Connect the PV array

Ensure that the solar module is not exposed to light. Ensure that the solar module does not exceed the maximum permissible input current. Connect the solar module connection cable to the correct polarity of the left pair of terminals on the solar charge controller (with the solar module symbol).



3) Connect the load

Connect the load cable to the correct polarity of the right pair of terminals on the solar charge controller (with the lamp symbol). To avoid any voltage on the wires, please connect the wire to the load before connect to the controller

4) Final step

Tighten all cables connected to the controller and remove all the debris around the controller (leaving a space of at least 15 cm).

4.6 Grounding

Be aware that the negative terminals of controller are interconnected and therefore have the same electrical potential. If any grounding is required, always do so on the negative wires.

CAUTION: For common-negative system, it is recommended to use a common-negative controller; but if in the common-negative system, some common-positive equipment are used, and the positive electrode is grounded, the controller may be damaged.

5 LCD Display

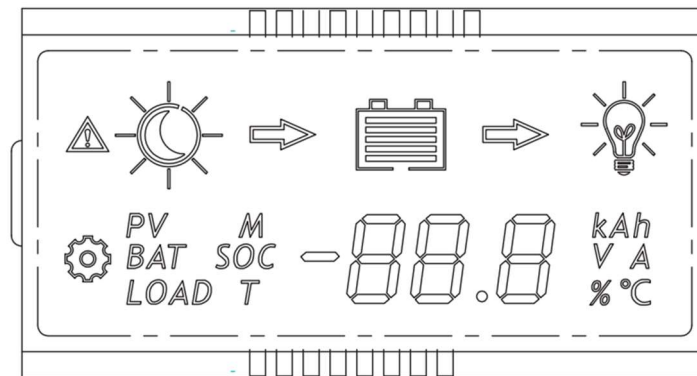

Daytech Pty Ltd

Web: www.daytech.io | Email: sales@daytech.io | Phone: 1300 866 970

Head Office & Factory: 614-616 Marion Road, Park Holme, SA 5043

Warehouse: 1167A South Rd St Marys SA 5042 | Daytech Pty Ltd | ABN: 84 602 165 024



5.1 Status Description

External Equipment	Icon	Status
PV Array		Daytime, not charging
		Daytime, charging
		Night
	<i>PV</i>	PV Voltage, current and Amp-hours
	<i>PV T</i>	Total charge Amp-hours of the solar panel
Battery		Battery capacity
		Battery voltage (programmable LVD)
	<i>BAT</i>	Battery current
	<i>BAT SOC</i>	Battery state of charge (in percent)
		Temperature
		Battery type (programmable)
Load		Load voltage (Programmable LVR)
	<i>LOAD</i>	Load current and Amp-hours
	<i>LOAD T</i>	Total discharge current into the load in Amp-hours
		Load mode (programmable)
		The load is connected
		The load is disconnected
Fault		Fault indication



5.2 Automatic display cycle

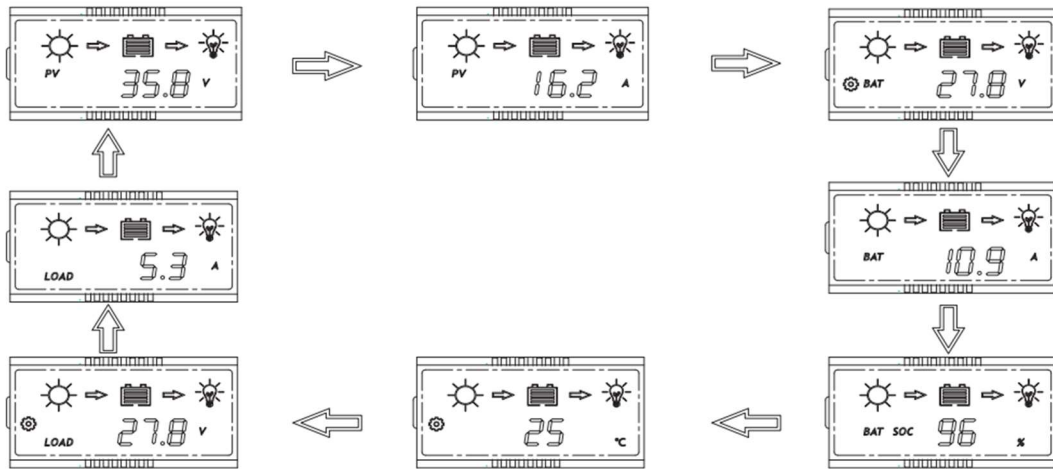

5.3 Moving through the menus

Pressing the OK button cycles through the interface

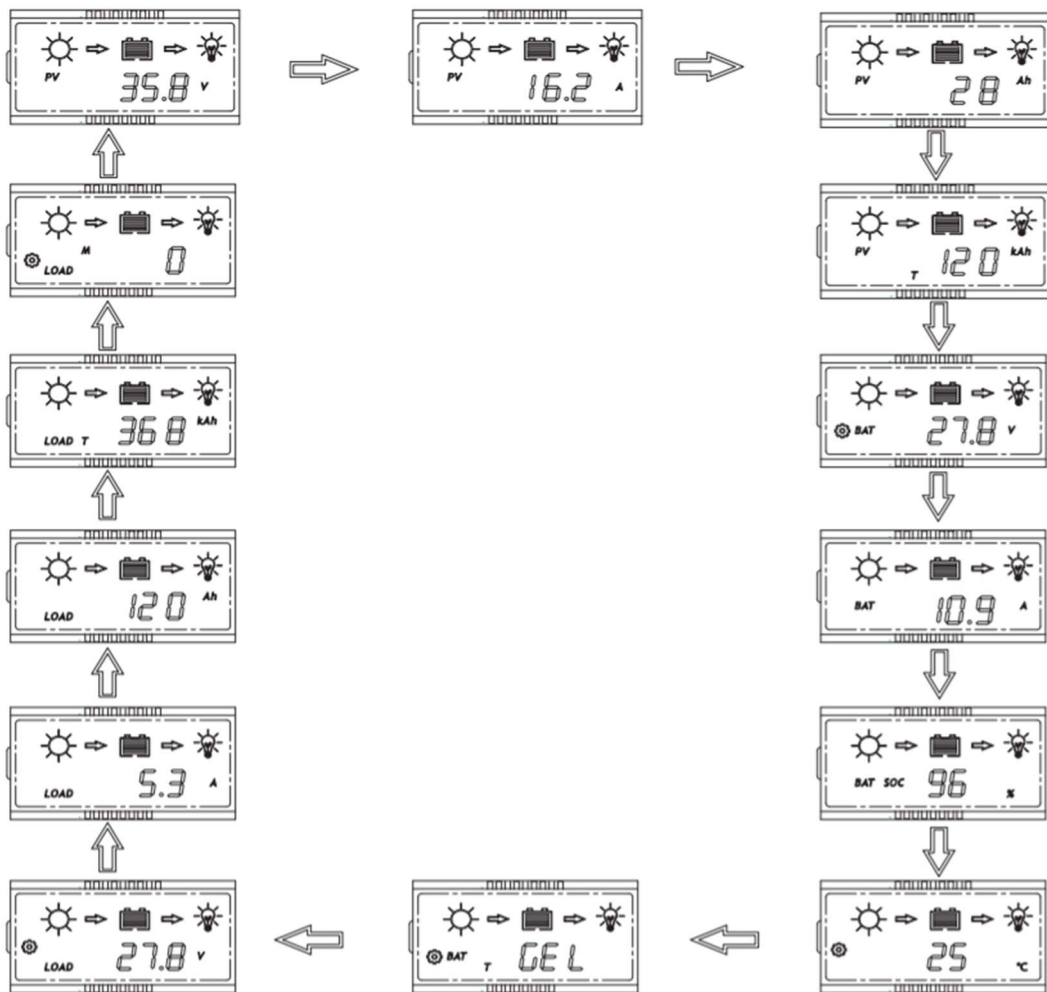











Daytech Pty Ltd

Web: www.daytech.io | Email: sales@daytech.io | Phone: 1300 866 970

Head Office & Factory: 614-616 Marion Road, Park Holme, SA 5043

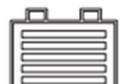
Warehouse: 1167A South Rd St Marys SA 5042 | Daytech Pty Ltd | ABN: 84 602 165 024

5.4 Fault Indicators

Status	Icon	Description
Short Circuit	  E1	Load off, fault icon display, load icon flashes, the LCD screen displays E1
Over Current	  E2	Load off, fault icon display, load icon flashes, the LCD screen displays E2
Low Voltage	  E3	Battery level shows empty, fault icon display, battery frame flashes, the LCD screen displays E3
Over Voltage	  E4	Battery level shows full, fault icon display, battery frame flashes, the LCD screen displays E4
Over Temperature	  E5	The charge and discharge are off, fault icon display, icon °C flashing, the LCD screen displays E5
Communication Failure	 E6	Display board failed to obtain controller data, fault icon display, the LCD screen displays E6
Controller can't identify the system voltage	 E7	Controller does not correctly identify system voltage, fault icon display, the LCD screen displays E7

5.5 Button Functions



MENU



OK

Mode

Button Sequence

Browse parameters

Quick press of Right

Pause display

Press both buttons for 1 second. LCD will be locked.
Press both buttons for 1 second to release lock

Set parameters

Press Left button for 1 second to enter setting mode when the  icon is on the display. This mode will exit automatically after 30 seconds.

Load On/Off

When the controller is in lighting mode, press the MENU button for 3 seconds to turn on the load. Press the MENU button again or wait for 1 minute for the load to turn off.

Daytech Pty Ltd

Web: www.daytech.io | Email: sales@daytech.io | Phone: 1300 866 970

Head Office & Factory: 614-616 Marion Road, Park Holme, SA 5043



Warehouse: 1167A South Rd St Marys SA 5042 | Daytech Pty Ltd | ABN: 84 602 165 024

5.6 USB Charging Ports

Some selected units have two USB charging ports with a total capacity of 2A at 5V, for use in charging mobile phones and other smart devices.

The USB voltage stops when the controller is in low voltage protection mode.

5.7 Parameters and Settings

When the  icon appears on the display, the parameter can be changed. Press the **MENU** button for 1 second. The  icon will flash. Press the **OK** button to change the parameter.

5.7.1 Low Voltage Protection

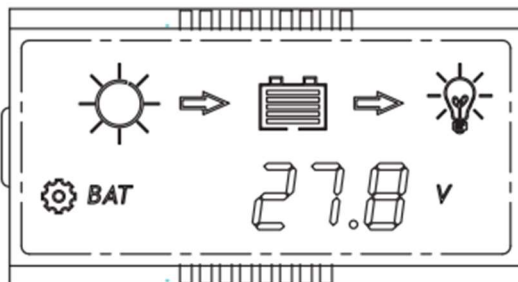

When the LCD is shown as left, press **MENU** for 1 second. The  icon flashes. You can now change the controller's low voltage protection.

1. Lithium Battery

In this setting, the low voltage protection setting range is 9.0V to 30.0V (default: 9.0V)

2. Liquid, Gel, and AGM Battery

The low voltage protection of the controller is divided into two types: battery voltage control and capacity control.

2.1 Battery control Voltage

Low voltage protection settings range is: 10.8~11.8V / 21.6~23.6V / 43.2~47.2V for 12V, 24V, and 48V systems, respectively. (Default: 11.2/22.4/44.8V)

2.2 Battery Capacity Control

Display	Low Voltage protection range
5 - 1	11.0~11.6V/22.0~23.2V/44.0~46.4V
5 - 2	11.1~11.7V/22.2~23.4V/44.4~46.8V
5 - 3	11.2~11.8V/22.4~23.6V/44.8~47.2V
5 - 4	11.4~11.9V/22.8~23.8V/45.6~47.6V
5 - 5	11.6~12.0V/23.2~24.0V/46.4~48.0V

5.7.2 Low Voltage Reconnect

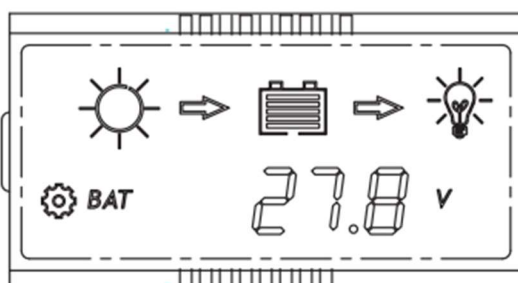

When the LCD is shown as left, press **MENU** for 1 second. The  icon flashes and you can set the controller's low voltage reconnect parameter.

1. Lithium Battery

When the battery type is Lithium, the low-voltage reconnect setting is 9.6 – 31.0V (default: 9.6V).

2. Liquid, Gel and AGM battery

The low voltage reconnect settings range is:

11.4~12.8V/22.8~25.6V/45.6~51.2V(default : 11.8/23.6/47.2V)

Daytech Pty Ltd

Web: www.daytech.io | Email: sales@daytech.io | Phone: 1300 866 970

Head Office & Factory: 614-616 Marion Road, Park Holme, SA 5043

Warehouse: 1167A South Rd St Marys SA 5042 | Daytech Pty Ltd | ABN: 84 602 165 024



Note: The low voltage recovery voltage (LVR) should be higher than the low voltage protection (LVD) by at least 0.6/1.2/2.4V.

5.7.3 Battery Type

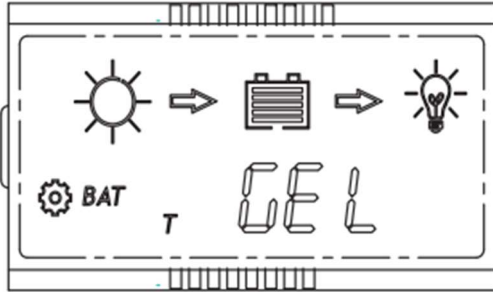



When the LCD shows as left, press **MENU** for 1 second. The  icon flashes. You can set the battery type.

Display	Battery type
GEL	GEL(Default)
L I 9	Liquid
AG -	AGM
L I	Lithium

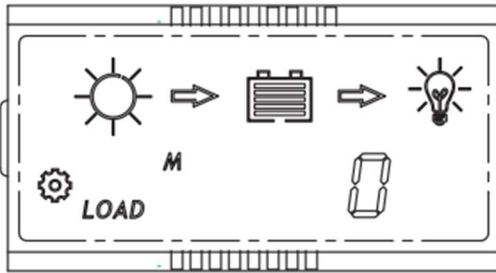
5.7.4 Load Mode



When the LCD shows as left, press **MENU** for 1 second. The  icon flashes. You can now set the load mode.

Display	Load Mode
	Always on Mode: The load is always connected.
	Dusk to Dawn mode: The load output is switched on between sunset and sunrise.
2 3 4 5 6 7 8 9	Evening mode: The load output will be switched on for 2~9 hours after sunset.
USE	Manual Mode: The load output can be switched on and off manually by pressing MENU quickly.

Note: If the controller turns off the load due to low voltage protection, overcurrent protection, short circuit protection or over temperature protection, the load will turn on automatically when the controller recovers from the protection state.



6 Troubleshooting, protection, and maintenance

6.1 Troubleshooting

Fault	Reason	Actions to take
E1	Short Circuit	Switch off all loads, remove short circuit, load will be reconnected after 1 minute automatically
E2	Over Current	Reduce the load, the controller will resume after 1 minute
E3	Battery Voltage too low	Load will be reconnected when the battery is recharged
E4	Battery voltage is too high	Check if other sources are overcharging the battery. If not, the controller is faulty.
E5	Over temperature	After the temperature drops, the controller will continue as normal.
E6	Communications failure	
E7	Battery voltage is abnormal at startup	Charge or discharge the battery so its voltage is within the normal operating range (8.5~15.5V or 20~30V or 40~60V).
Battery cannot be charged during the day	PV array reverse polarity	Check panels and connection of wires.

6.2 Protection

Protection	Description
PV Over Current	The controller will limit charging power in rated charge power. An over-sized PV array will not operate at maximum power point
PV Short Circuit	When PV short circuit occurs, the controller will stop charging. Remove it to start normal operation.
PV Reverse Polarity	Fully protection against PV reverse polarity, no damage to the controller. Correct the connection to start normal operation.
Battery Reverse Polarity	Full protection against battery reverse polarity, no damage to the controller will result. Correct the connection to start normal operation.
Battery Over Voltage	If there are other energy sources to charge the battery, when the battery voltage exceeds 15.8 /31.3/62.3V, the controller will stop charging to protect the battery from overcharging damage.
Battery Over Discharge	When battery voltage drops to the setting voltage point of Low Voltage Disconnect, the controller will stop discharging to protect the battery from over discharging damage.
Load Over Current Protection	If the load current exceeds the maximum load current rating 1.25 times, the controller will disconnect the load.

Daytech Pty Ltd

Web: www.daytech.io | Email: sales@daytech.io | Phone: 1300 866 970

Head Office & Factory: 614-616 Marion Road, Park Holme, SA 5043

Warehouse: 1167A South Rd St Marys SA 5042 | **Daytech Pty Ltd** | ABN: 84 602 165 024



Load Short Circuit Protection	Once a load short circuit happens, short circuit protection will start automatically.
Over Temperature Protection	The controller detects the internal temperature through an internal sensor. When the temperature exceeds the setting value, the charging current will lower down followed by the decrease of temperature, to control the controller's temperature rise. When the internal temperature exceeds the setting over temperature protection threshold, the controller stops working. The controller is restored after the temperature is lowered.
Damaged Remote Temperature Sensor	If the temperature sensor is short-circuited or damaged, the controller will assume a default temperature of 25°C to prevent the battery from being damaged from overcharging or over discharging.

6.3 Maintenance

The following inspections and maintenance tasks are recommended at least two times per year for best performance.

Warning: Risk of electric shock. Make sure all power is turned off before working on an installation.

- Make sure no blockage to airflow exists around the controller. Clear up any dirt and fragments on radiator.
- Check all the wires to make sure insulation is not damaged. Repair or replace some wires if necessary.
- Tighten all the terminals. Inspect for loose, broken, or burnt wire connections.
- Check and confirm that LCD is consistent with requirements. Pay attention to any troubleshooting or error alerts. Take corrective action if necessary.
- Confirm that all the system components are ground connected tightly and correctly.
- Confirm that all the terminals have no corrosion, no damaged insulation, high temperature or burnt/discoloured appearance. Tighten terminal screws to the suggested torque. Check for dirt, nesting insects and corrosion.

Daytech Pty Ltd

Web: www.daytech.io | Email: sales@daytech.io | Phone: 1300 866 970

Head Office & Factory: 614-616 Marion Road, Park Holme, SA 5043

Warehouse: 1167A South Rd St Marys SA 5042 | Daytech Pty Ltd | ABN: 84 602 165 024



7 Technical Data

Battery Charger Chemistry	Gel, AGM, Liquid, Lithium (default: Gel) and optional User Defined – Can program for various chemistries, such as Li-ion, Lithium Iron Phosphate (LiFePO4), LTO, etc.
Nominal System Voltage	DT2010A: 12VDC / 24VDC Auto Detect DT3010A: 12VDC / 24VDC Auto Detect DT4010A: 24VDC / 48VDC Auto Detect
Rated Charge Current	DT2010A: 20A DT3010A: 30A DT4010A: 40A
Max. Discharge current (Load)	DT2010A: 20A DT3010A: 30A DT4010A: 30A
Low Voltage Disconnect	DT2010A: 10.8~11.8V/21.6~23.6V DT3010A: 10.8~11.8V/21.6~23.6V DT4010A: 18.0~60.0V(Lithium, default: 21.0V)
MPPT Voltage Charging Range	DT2010A: <14.5VDC ~ 29VDC @25degC DT3010A: <14.5VDC ~ 29VDC @25degC DT4010A: <29.0/58.0V@25°C
Max PV Input Power	DT2010A: 260W(12VDC) / 520W (24VDC) DT3010A: 390W(12VDC) / 780W (24VDC) DT4010A: 1000W(24VDC) / 2000W (48VDC)
Max PV Voltage	DT2010A: 100V(-20°C), 90V(25°C) DT3010A: 100V(-20°C), 90V(25°C) DT4010A: 150V(-20°C), 138V(25°C)
Self-Consumption	≤15mA
Communication Interface	Optional RS485 (RJ45) – needs to be specified at time of order
Grounding	Common Negative
Dimensions (mm)	DT2010A: 189 * 182 * 64 DT3010A: 189 * 255 * 69 DT4010A: 189 * 255 * 89
Power Cabling	Use flex panel wire for higher Current Carrying Capacity. DT2010A: 10mm ² DT3010A: 16mm ² DT4010A: 16mm ²
Weight	DT2010A: 1.3kg DT3010A: 2.0kg DT4010A: 2.5kg
Temperature Range	Operating Temperature: -30 ~ +55°C Storage Temperature: -30 ~ +75°C
Humidity Range	≤95% (RH)
Package material	Cast Aluminium Housing, powder coated
IP Rating	IP32, requires enclosure for outdoor use.
Warranty	2 years Limited*

* Limited Warranty – Warranty applies for use within specified temperature, current and voltage parameters ONLY.

Daytech Pty Ltd

Web: www.daytech.io | **Email:** sales@daytech.io | **Phone:** 1300 866 970

Head Office & Factory: 614-616 Marion Road, Park Holme, SA 5043

Warehouse: 1167A South Rd St Marys SA 5042 | **Daytech Pty Ltd** | **ABN: 84 602 165 024**